

**1.5 A Single-Phase Glass Passivated Bridge Rectifiers**  
Rectifier Reverse Voltage 50 to 1000V



**Features**

- This series is UL listed under the Recognized Component Index, file number E142814
- The plastic material used carries Underwriters Laboratory flammability recognition 94V-0
- Surge overload ratings to 50 amperes
- Ideal for printed circuit board application
- High temperature soldering guaranteed 265 °C /10 seconds at 5 lbs (2.3kg) tension

**Mechanical Data**

Case: Molded plastic  
 Terminals: Plated leads solderable per MIL-STD-202, Method 208  
 Polarity: Marked on body  
 Mounting Position: Any  
 Weight: 0.04 ounce, 1.0 grams (approx)

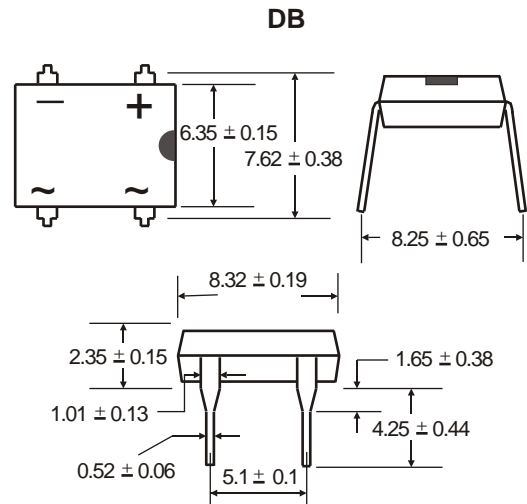

Dimensions in millimeters ( 1mm =0.0394" )

**Maximum Ratings & Thermal Characteristics**

Rating at 25°C ambient temperature unless otherwise specified, Resistive or Inductive load, 60 Hz.  
 For Capacitive load derate current by 20%.

Parameter	Symbol	DB151	DB152	DB153	DB154	DB155	DB156	DB157	unit
Maximum repetitive peak reverse voltage	VRRM	50	100	200	400	600	800	1000	V
Maximum RMS bridge input voltage	VRMS	35	70	140	280	420	560	700	V
Maximum DC blocking voltage	VDC	50	100	200	400	600	800	1000	V
Maximum average forward rectified output current at TA=40°C	IF(AV)	1.5							A
Peak forward surge current single sine-wave superimposed on rated load (JEDEC Method)	IFSM	50							A
Rating for fusing ( t<8.3ms)	I <sup>2</sup> t	10							A <sup>2</sup> sec
Typical thermal resistance per element (1)	ReJA	110							°C / W
Typical junction capacitance per element (2)	Cj	25.0							pF
Operating junction and storage temperature range	TJ, TSTG	-55 to + 150							°C

**Electrical Characteristics**

Rating at 25°C ambient temperature unless otherwise specified. Resistive or Inductive load, 60Hz.  
 For Capacitive load derate by 20 %.

Parameter	Symbol	DB151	DB152	DB153	DB154	DB155	DB156	DB157	Unit
Maximum instantaneous forward voltage drop per leg at 1.5A	VF	1.1							V
Maximum DC reverse current at rated DC blocking voltage per element	IR	10 500							μA

**Notes:** (1)Thermal resistance from Junction to Ambient on P.C.board mounting.  
 (2)Measured at 2.0MHz and applied reverse voltage of 4.0 volts.

# Rating and Characteristic Curves ( $T_A=25^\circ\text{C}$ Unless otherwise noted )

## DB101 thru DB107

**Fig. 1 Derating Curve for Output Rectified Current**

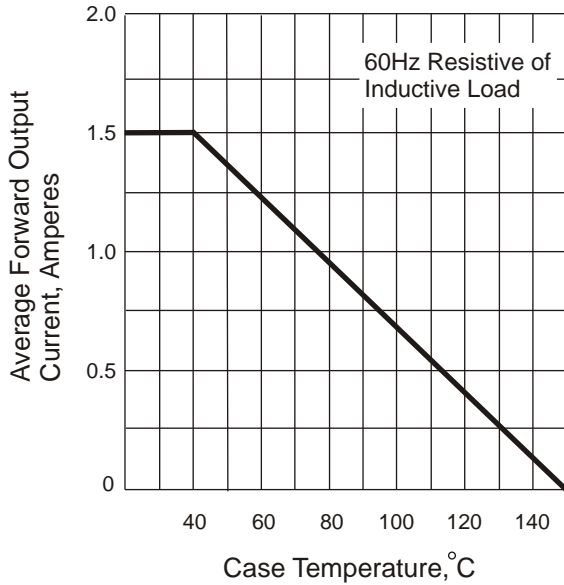

**Fig. 2 Maximum Non-repetitive Peak Forward Surge Current**

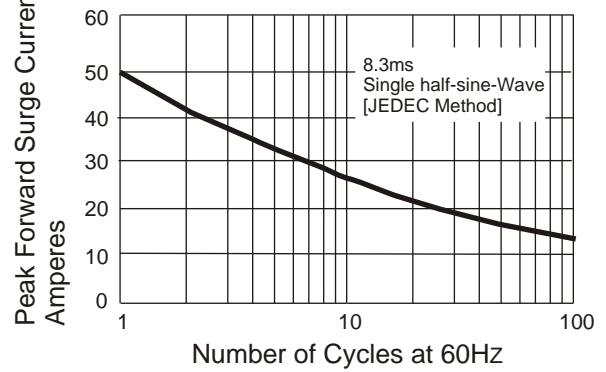

**Fig. 3 Typical Instantaneous Forward Characteristics**

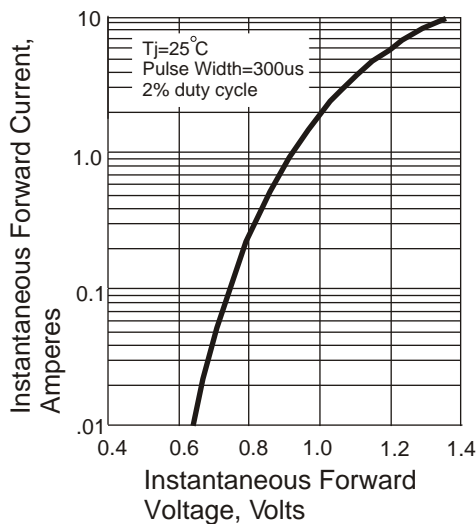

**Fig. 4 Typical Revers Characteristics**

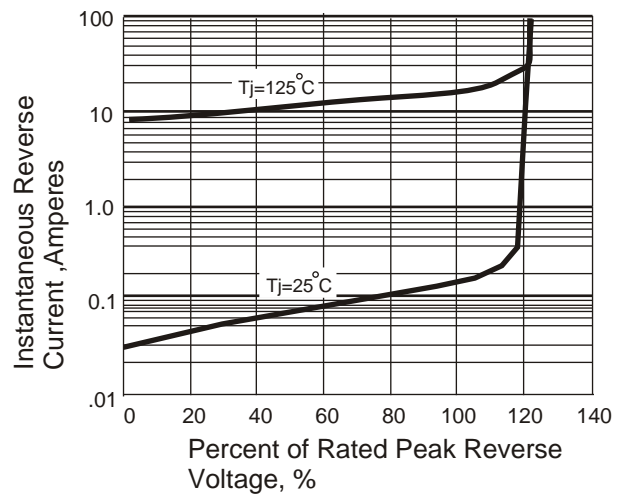

**Fig. 5 Typical Junction Capacitance**

